

ORIGINAL OPERATING INSTRUCTIONS  
Read carefully and retain for future reference



Towel Rail

Model  
NOOR

Type : NOOR500 / NOOR750

## IMPORTANT WARNINGS

Dear Customer:

Thank you for your confidence in us by purchasing this Towel Rail. These appliances are extremely safe, silent and easy to install.

They do not require special maintenance. They are made of aluminum, a material of high durability. Before starting it for the first time, carefully read these instructions. Retain them for future references.

## GENERAL SAFETY INSTRUCTIONS

1. Please read carefully these instructions before starting the device for the first time. Keep these instructions, as well as the guarantee, your invoice and if possible, the complete packing with all the elements inside.
2. The guarantee will cease to be valid in the case of not following the recommendations of this manual.
3. Before connecting the appliance, make sure the mains voltage is the 230 Volts, and correspond to the marked on the nameplate of the appliance.
4. Check that the power is sufficient to supply the appliances. The total draw of the Towel Rail currents must not exceed the capacity of the circuit breaker that protects them.
5. This Towel Rail cannot be used in rooms with presence of gases or other flammable products (glues, etc...).
6. **WARNING:** To prevent overheating, do not cover the device. Do not use the device to dry clothes.
7. Make sure the power cable or other objects do not come into contact with the Towel Rail surface while in operation.
8. If the power cable becomes damaged it must be replaced by the manufacturer or a suitably qualified trades person. Failure to comply may danger your safety and voids your warranty.
9. Check the device and the supply cord regularly. Do not turn the device on if it is damaged.
10. **PRECAUTION:** Some parts of this product can reach very high temperatures and cause burns. Pay special attention when children or vulnerable people are around.
11. Do not place the device straight under a power socket.
12. Children under the age of three should not be allowed to touch or play with the Towel Rail and should be supervised at all times.
13. This device can be used by children under 8 years of age, as well as by people with reduced physical, sensory or mental capabilities when suitably supervised and only when they have been provided the instructions regarding the use of the device and have understood the risks that could derive from it. Cleaning must only be carried out by an appropriate adult.
14. Children between 3 and 8 years should not turn on or off the device, unless this is installed or placed in a normal position and that children are under proper supervision or have received instructions regarding the use of the device as security and they have perfectly understood the potential dangers. Children between 3 and 8 years old should not connect, adjust or clean the appliance or perform any maintenance measure.
15. **Warning:** Do not use this heater near baths, showers or swimming pools. It should not be possible to access the device's controls from the bath, shower or any other surface that is in contact with water. (Its use in zones 0 or 1 in bathrooms is totally prohibited: seek advice from a qualified electrician).
16. For greater safety, this appliance is provided with a device that interrupts its operation in the case of overheating.
17. This Towel Rail has been designed exclusively to be fixed to the wall. For further information on the fixing systems, consult the section "INSTALLATION AND WALL MOUNTING" of this manual.
18. Do not use accessories that have not been recommended by the manufacturer, as they could entail a potential risk to the user, and damage the device. Use only original accessories.
19. Keep all the packaging elements (plastic bags, cardboard and polyethylene) out of the reach of children, as they can cause potentially dangerous situations.
20. Use this device only for domestic / light commercial use and the tasks for which it has been designed. This device has not been designed for industrial use. It must not be used outdoors, in greenhouses or for animal husbandry. Keep it away from heat, direct sunlight, humidity and cutting tools. Do not under any circumstances immerse in water or use this device with wet hands. In the case of humidity or water in the device, immediately disconnect the power supply and do not touch the wet parts.
21. Do not attempt to service the device yourself. Contact a qualified technician.
22. To disconnect the transmitter from the mains pull the plug, never of the supply cord.
22. Respect the "SPECIFIC SAFETY INSTRUCTIONS FOR THIS APPLIANCE" listed below.
23. **WARNING:** In order to avoid danger to very young children, this appliance should be installed so that the lowest heated tube is at least 600 mm above the ground.
24. **WARNING:** This appliance is only intended for drying clothes washed with water.

## SPECIFIC SAFETY INSTRUCTIONS FOR THIS DEVICE

- The appliance must remain in a vertical position.
- Make sure the appliance is secured at all times. Please adhere to the installation distances indicated in this

guide.

- This Towel Rail is designed to be connected by plug to the electric installation and fixed to the wall installation. Follow the instructions in "INSTALLATION".
- The guarantee will not apply if these instructions have not been observed.

## INSTALLATION

- During the first use and for a few minutes, could occur smells and noise due to the dilatation of some internal parts. This is normal, so you must provide adequate ventilation. The smells are momentary and quickly will dissipate.
- Fix the Towel Rail to a firm wall and make sure it is well-levelled.
- The Towel Rail must be away, at a minimum distance of 15cm from any combustible material, etc.
- Allow for a minimum distance of 1 m, from the front of the unit to any obstacles that could hinder its operation.
- Also keep a minimum distance of 15 cm between the appliance and the side walls and any other obstacles (walls, for example) that may affect its function.
- **WARNING:** If this appliance is installed in a bathroom, it must be installed only within Zones 2 or Outside Zones (Zone3), according BS 7671 Requirements for Electrical Installations, Section 701. The installation of this appliance within Zones 0 or 1 of a bathroom is totally prohibited. The figure 2 below is only for information purposes, we suggest you contact a professional electrician.

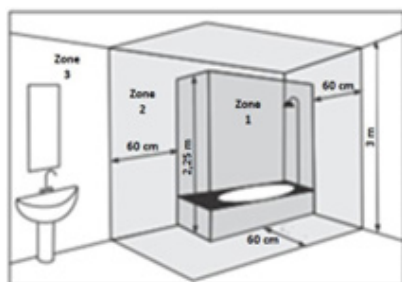

Zone 1: Appliances supplied to Safety Extra Low Voltage (SELV).

Zone 2: Electrical Appliances Class II – IP X4 Zone 3: Electrical Appliances protected by RCD 30mA

## WALL-MOUNTING

The towel radiator is equipped with the following elements:

- 4 towel radiator suspension brackets (Fig. 1).



Fig. 1

1. Place the template at a minimum recommended height of 1 m, against the wall where the towel radiator will be placed.
2. Mark the location of the 4 holes on the wall.
3. Drill four holes for 8 mm plugs.
4. Place on the wall the larger diameter brackets ( $\Phi 26$ ) (as shown in the figure) with the 4 screws for the 8 mm plugs and the corresponding 4 washers (Fig. 2).



Fig. 2

5. Place the smaller diameter brackets ( $\Phi 19$ ) on the device with the 4 M4 screws and 4 M4 washers according to figure 3.

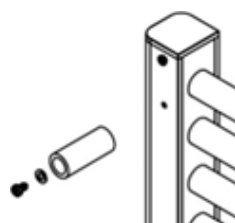
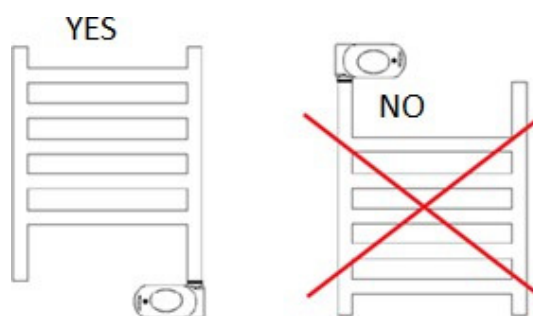
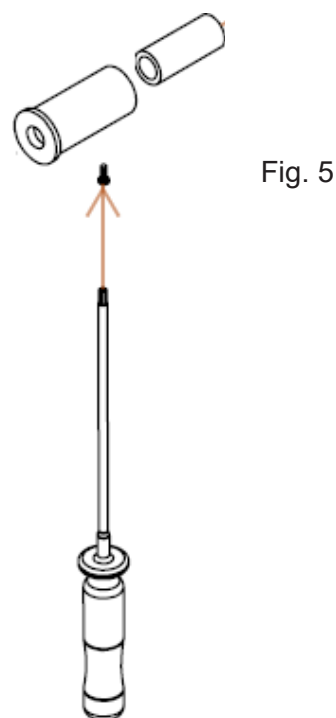
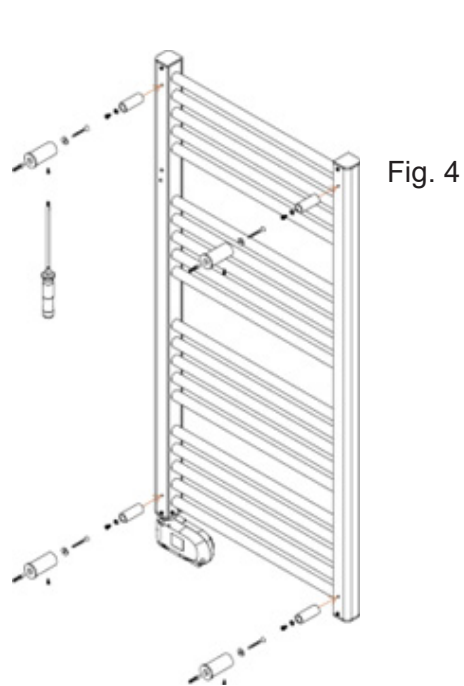

Fig. 3

6. Insert the brackets ( $\Phi$  19) fixed in the appliance into the brackets ( $\Phi$  26) fixed on the wall and screw the fastening screw of the wall bracket, as shown in figures 4 and 5.



#### ELECTRIC SUPPLY CONNECTION

This appliance is equipped with a supply cord H05V2V2-F 2x1.0mm<sup>2</sup> and bipolar plug without earthing. Connect the plug to the base outlet.

Check the condition of your electrical installation and connection cables.

This appliance doesn't require earthing connection, due it has double electrical insulation.

Contact a licensed electrician for assistance.

#### TECHNICAL CHARACTERISTICS

Type	NOOR 500	NOOR 750
Rated Voltage	230 V~	230 V~
Rated Frequency	50 Hz	50 Hz
Rated Power Input	500 W	750 W
Electrical Protection Class	II	II
IP Protection Deg.	IP24	IP24
Dimensions (LxHxD) (mm)	505x785x100	505x1100x100
Weight (kg)	2.95	5

#### HOW TO PLACE TOWELS

The towels will hang on the horizontal towel rail, letting them hang from the back and the front.

It is recommended that it be in the upper horizontal tube of each tube set.

# PROGRAMMABLE DIGITAL THERMOSTAT

## Introduction

•Seven operational modes: Comfort, Night, Antifreeze, Fil-Pilote, Chrono, Timer- 2h, Stand-by.

“Comfort” mode: The thermostat keeps the room temperature at the value set by the user.

“Night” mode: The electronic control keeps the room temperature to a level below the configured “Comfort” value.

“Antifreeze” mode: The electronic control keeps the room temperature above 7°C. “Fil-Pilote” mode: The operations of device are controlled through the signal received from the “Fil-Pilote” system.

“Timer-2h” mode: The electronic control powers the heating element for a period of 2 hours independently of the configured temperature. At the end of the 2 hours time period, the device returns to previous operational mode. For safety reasons, during the 2 hours time period the room temperature is automatically controlled in order not to exceed 32°C.

“Chrono” mode: The electronic control operates according to a daily/weekly program. The program is user defined.

-In “Stand-by”: The electric resistance is not powered and all lights are turned off, however the device is still operative.

Further features:

•Large display showing the configured temperature, time, program and current operational mode.

•The user according to his needs can configure the daily/weekly program.

•The “Open Window Detection” function enables detecting of an open window by sensing a sudden decrease of the temperature in the room. In such a case, the device deactivates the heating element for a maximum of 30 minutes or until an increase of the room temperature reveals that the window has been closed.

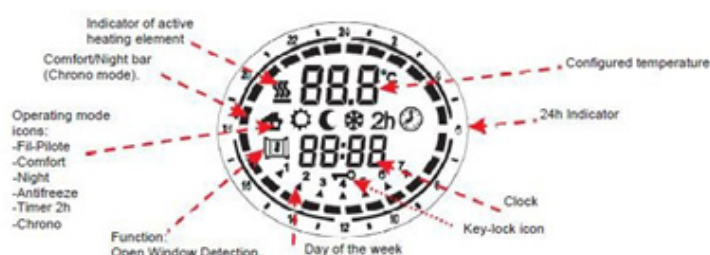

## 1. MISE EN MARCHE/STAND-BY

### 1. POWER ON / STAND-BY

Press the [On/Stand-by] key to turn on the device or to enter the “Stand-by” mode. When activated, the bottom part of the display shows the current time, while the configured operative mode and the temperature are shown in the upper part. When in “Stand-by” mode current time, day of the week and the message: “Stb” are displayed.

NOTE: When the device goes into “Stand-by” mode it beeps twice for 0.5s. When the device is activated it beeps once for 1s.

Example in “Comfort” mode.



Example in “Stand-by” mode.



## 2. “COMFORT” and “NIGHT” MODES

Two different levels of temperature can be set:

-”COMFORT” temperature: It is the temperature used for “Chrono”, “Fil-Pilote” and “Comfort” modes.

-”NIGHT” temperature: It is the temperature used for the “Night” and “Chrono” modes.

The desired temperature can be set pressing the [+ ] e [- ] buttons. The range of configurable temperature is 7°C - 32°C. IMPORTANT!

The temperature of “Night” mode must be below to the “Comfort” mode temperature. For this reason the “Night” mode temperature can be set to a value between 7°C and the (configured “Comfort” mode temperature - 0.5°C).

The temperature of “Comfort” mode can be configured in the whole (Night temperature + 0.5°C) ÷ 32°C range.

## 3. OPERATING THE DEVICE

Press the [PROG] button to select the desired operative mode. An icon on the display indicates the selected operating mode, according to the following table:

			2h	
Confort	Night	Antifreeze	Timer 2H	Chrono

### COMFORT MODE

The "Comfort" stably maintains the room temperature to a selected value. To set this operative mode:

- Press the [Prog] button until the display shows the "Comfort" icon
- Set the desired temperature through [+] and [-] buttons.

### NIGHT MODE

The "Night" mode sets a value of temperature below the "Comfort" temperature value.

It is suggested to set this operating mode during the night or when the room is not occupied for 2 or more hours.

- Press the [Prog] button until the display shows the "Night" icon
- Set the desired temperature through [+] and [-] buttons.

### ANTIFREEZE MODE

In "Antifreeze" mode the temperature is fixed to 7°C. The device activates the heating element when the room temperature falls below 7°C. It is suggested to set

this operating mode when the room is not occupied for several days. Press the [Prog] button until the display shows the "Antifreeze" icon

### TIMER-2H MODE

The "Timer 2h" mode can be used to quickly warm up the room or to speed up towel drying.

- Press the [Prog] button until the display shows the "2h" icon.

The device is activated at the maximum power for 2 hours, up to a maximum room temperature of 32°C. The "Timer-2h" mode is automatically deactivated after a period of 2 hours and the device returns to the operative mode previously set. The user can switch to another operative mode at any time by simply pressing the [PROG] button.

### FIL-PILOTE MODE (Only for product versions equipped with "Fil-Pilote". Only France)

In "Fil-Pilote" mode the device is managed by a central control system that sets the operating mode for all the connected devices. The device operates with the most advanced "Fil-Pilote" system with six commands, which allows the following functions:

1. Standby: power off the heating element, the device remains active.
2. Comfort: maintains the "Comfort" temperature set by the user.
3. Eco: maintains the room temperature 3,5°C below the "Comfort" temperature.
4. Anti-freeze: maintains the room temperature at 7°C.
5. Eco-1: maintains the room temperature 1°C below the "Comfort" temperature.
6. Eco-2: maintains the room temperature 2°C below the "Comfort" temperature. The user can set the desired temperature on the device:

-Press the [Prog] button until the "Fil-Pilote" icon is displayed. Set the desired temperature through the [+] and [-] buttons.

### CHRONO MODE

This operating mode allows the user to configure different temperature values for each hour of each day of the week.

The "Comfort" / "Night" temperatures and the related time intervals can be thus programmed.

-To activate this function, press the [PROG] button until the "Chrono" icon is displayed.

Programming the "Chrono" mode

- a) Setting the current day of the week and time
  - Enter into "Stand-by" mode and press the [-] button at least 3 seconds.
  - On the upper part of the display the message "Set" will be displayed
  - To set the day and time press the [+] button until the bottom part of the display the message "TED" is displayed (see picture).

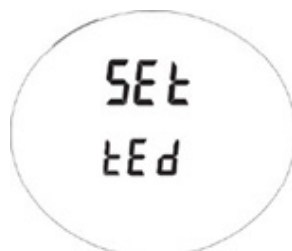

Press the [Prog] button to enter the editing mode

- The blinking arrow indicates the currently selected day: Pressing the [+] / [-] buttons the desired day can then be set

- Press again the [Prog] button to confirm the selected day. After that, the procedure for entering the time starts and the display shows the currently selected time. "Hours": Use the [+] and [-] buttons to set the correct hour and confirm the selected value pressing the [Prog] button.

Minutes: Same procedure as for the hours. Confirm the selected value by pressing the [Prog] button.

- At the end of the procedure, the thermostat returns into "Stand-by" mode.

b) Setting the program for the "Chrono" mode

- Enter into "Stand-by" mode and press the [-] button at least 3 seconds.

- On the upper part of the display the message "Set" will be displayed

- To set the day and time press the [+] button until the bottom part of the display the message "Prog" is displayed (see picture).



- Press the [Prog] button to enter the editing mode

- Now a time sequence can be defined for each day of the week.

The procedure starts with day 1, and the desired sequence can be configured with the [+] and [-] buttons:

For each hour of the day, it is then possible to assign either the "Comfort" temperature (full bar indication displayed) by pressing the [+] button or the "Night" temperature (empty bar) by pressing the [-] button (see picture).



Press [PROG] to confirm the entered configuration for day 1, and repeat the same procedure for the remaining 6 days of the week.

#### KEY LOCK

It is possible to lock the buttons of the device to avoid inadvertent modifications of the settings.

Press together the [PROG] buttons for 3 seconds to lock all the buttons except the [On/Stand-by] button. The key-lock icon is activated on the display.

To unlock the buttons press again together the [PROG] buttons for 3 seconds.

The key-lock icon disappears on the display



### “Open Window Detection” function

The “Open Window Detection” function enables detecting of an open window by sensing a sudden decrease of the temperature in the room. In such a case, the device deactivates the heating element for a maximum of 30 minutes or until an increase of the room temperature reveals that the window has been closed.

To activate this function:

- Enter into “Stand-by” mode.
- Press the [+] button for 3 seconds.
- Press the [+] button to activate / deactivate the function
- Press the [Prog] button to commit and return into “Stand-by” mode

When this function is enabled, the “Open Window” icon on the display is lit.

When the device detects that the window is potentially opened, the “Open Window” icon starts blinking

When the function is disabled the “Open Window” icon is not shown on the display.

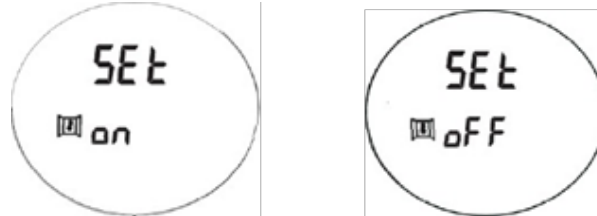

Note: The device could fail in detecting an opened window e.g. if the thermostat is located on an isolated area of the room and far from air currents or if the thermostat is placed close to an external heating source, or if the temperature variation in the room is too slow.

### THERMAL SAFETY

In the case of overheating, a safety device automatically cuts the radiators operation. After cooling the radiator will automatically reset.

### MAINTENANCE

Your radiator requires no regular maintenance, however, to ensure its good operation:

Always disconnect the device from the mains before performing any cleaning or maintenance operation.

Let it cool down before cleaning.

Do not use detergent, solvent, abrasive products or any other chemical product to clean the radiator.

NEVER immerse the device in water or any other liquids.

You can use a vacuum or flexible brush to clean the air grilles. This maintenance must be carried out regularly to ensure optimum performance. Ensure the radiator is totally dry before turning it back on.



2014/30/EC EMC DIRECTIVE	EN 55014-1:2006 + A1:2009 + A2:2011 EN 55014-2:1997 + A1:2001 + IS1:2007 + A2:2008 ==> Cat. 2 EN 61000-3-2:2014 EN 61000-3-3:2013
2014/35/EC LV DIRECTIVE	EN 60335-2-30:2009 + CORR:2010 +A11:2012 EN 60335-1:2012 +AC:2014 +A11:2014 + A13:2017 EN 60335-2-43:2004 EN 62233:2008 +CORR:2008
2011/65/UE RoHS DIRECTIVE	EN 62321-1:2013
2009/125/EC (ErP Directive) (2005/32/EC)	UE 2015/1188

Models: NOOR					
Item	Symbol	Value	Unit	Item	Unit
Heat output 750				<b>Type of heat output/room temperature control (select one)</b>	
Nominal heat output	P <sub>nom</sub>	0.75	KW	single stage heat output and no room temperature control	NO
Maximum continuous heat output	P <sub>max,c</sub>	0.75	KW	Two or more manual stages, no room temperature control	NO
<b>Auxiliary electricity consumption</b>				with mechanic thermostat room temperature control	NO
At nominal heat output	e <sub>lmax</sub>	0.75	KW	with electronic room temperature control	NO
In standby mode	e <sub>lSB</sub>	0.0005	KW	electronic room temperature control plus day timer	NO
Heat output 500				electronic room temperature control plus week timer	NO
Nominal heat output	P <sub>nom</sub>	0.5	KW	<b>Other control options (multiple selections possible)</b>	
Maximum continuous heat output	P <sub>max,c</sub>	0.5	KW	room temperature control, with presence detection	NO
<b>Auxiliary electricity consumption</b>				room temperature control, with open window detection	YES
At nominal heat output	e <sub>lmax</sub>	0.5	KW	with distance control option	NO
In standby mode	e <sub>lSB</sub>	0.0005	KW	with adaptive start control	YES
				with working time limitation	YES
				with black bulb sensor	NO
Contact details					

Requirements regarding ecodesign for local heating:

$$\eta_s = \eta_{s,on} - 10\% + F(1) + F(2) + F(3) - F(4) - F(5)$$

$$\eta = 40 - 10\% + 0 + 7 + 2 - 0 - 0 = 39\%$$

## RECYCLING (Disposal of the product at the end of its useful life)



According to European Directive 2012/19/UE, on waste electrical and electronic equipment (WEEE), old electrical household appliances cannot be disposed of in the usual municipal containers; they have to be collected separately to optimise the recycling of the components and materials that comprise it, and reduce the impact on human health and the environment.

The crossed-out wheeled bin is marked on all Electrical and Electronic products, to remind the consumer of their obligation to dispose of them separately.

The consumer must contact the local authority or the vendor to learn about the correct disposal of his/her old electrical household appliance.

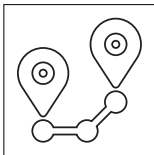

Sofia  
50 Boulevard "Professor Tsvetan Lazarov"



+359 885 310 311  
+359 886 500 150



[service@tedanbg.com](mailto:service@tedanbg.com)



[www.tedan.bg](http://www.tedan.bg)